

BUSTER+PUNCH

LONDON

[product.

L-BAR

[type. **HARDWARE.**]

[knurl. **LINEAR.**]

[detail. **TORX SCREW.**]

ダイヤモンドカット仕上げ・LINEARシリーズ
バックプレート付L-BAR+トルクスネジ

[finish. **STEEL.**]



[finish. **BRASS.**]



[finish. **GUN METAL.**]



[finish. **BLACK.**]



[finish. **BURNT STEEL.**]

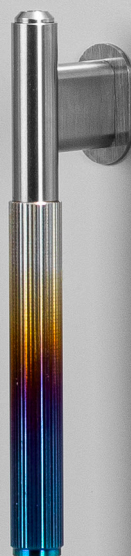

[type. **HARDWARE.**]

[info. **MEASUREMENTS.**]

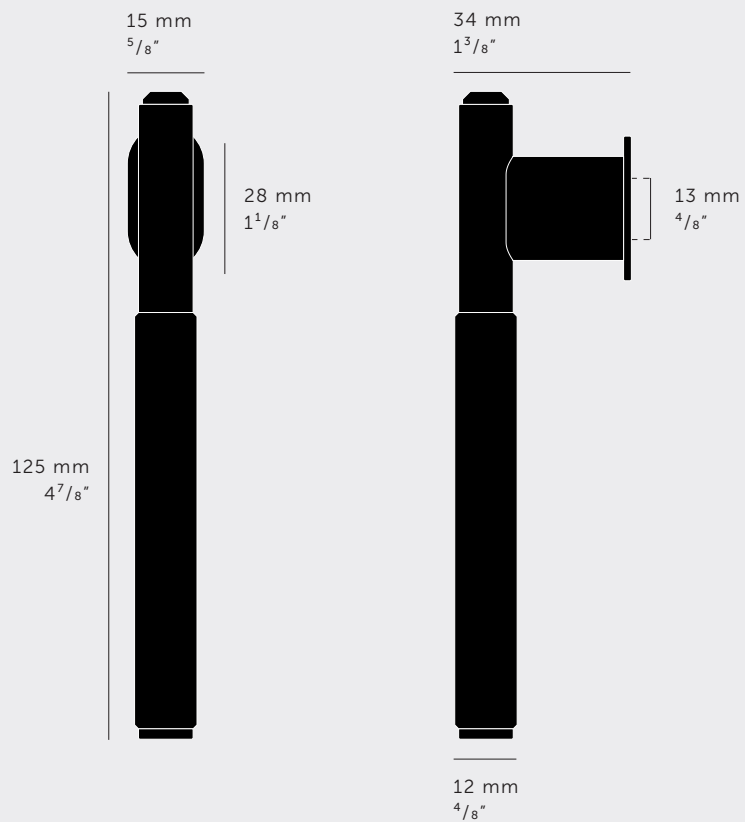

[info. **仕様・図面**]

Lバー x 1

背面固定式

最大厚さ18mm まで対応





*18mm以上の厚さにはM6ネジ
以上の物が必要

[info. **カラー・SKUコード**]

[finish.]

[UK.・JP.]

[US.]

 Steel	GLB-07325	NLB-07370
 Burnt Steel	GLB-36440	NLB-36450
 Brass	GLB-05326	NLB-05371
 Gun Metal	GLB-35329	NLB-35373
 Black	GLB-02328	NLB-02374

[info. **取扱方法**]

髪の毛等が付着していない湿った布で、化学薬品を使用せずに拭いて下さい。
全ての仕上げ加工は経年劣化が起こりやすい点をご了承ください。

[info. **付属品**]

1x オーバルワッシャー

2x M6 x 25 mm ネジ



1 pcs

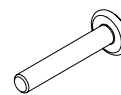

2 pcs